

Eliminator HD201 Actuator
Without Switch Tracks for Mounting Limit Switches
Metric Dimensions

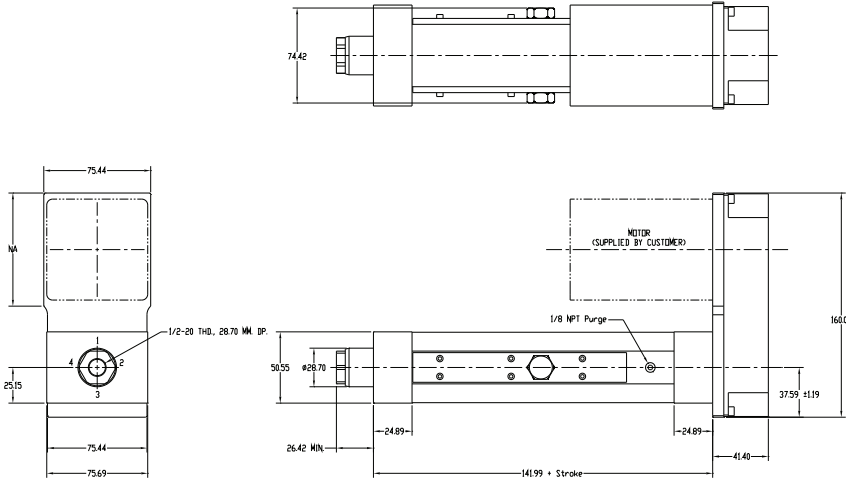

Motor Mount Configurations (choose one)

HD201 Parallel Offset Motor Configuration



HD201 Inline Motor Configuration

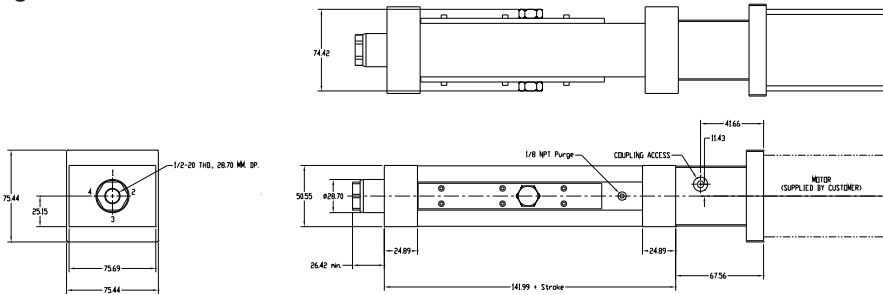

HD201 Rod End Conditions (choose one)

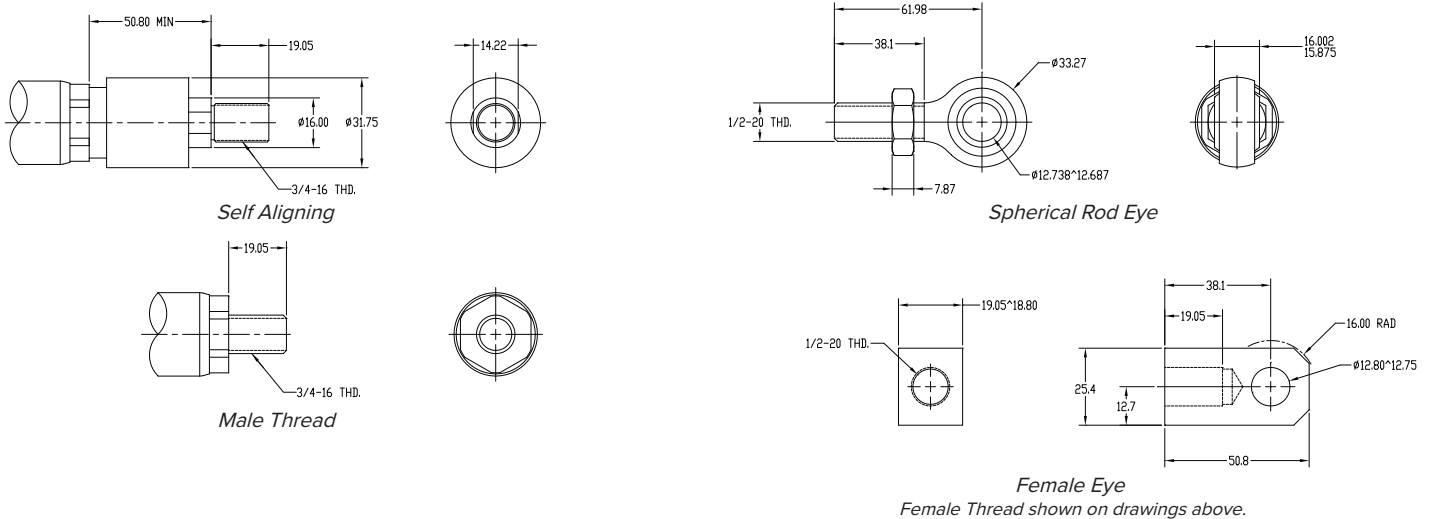

Eliminator HD201 Actuator
Without Switch Tracks for Mounting Limit Switches
Metric Dimensions



HD201 Actuator Mount Configurations (*choose one*)

HD201 Bottom Mount Dimensions

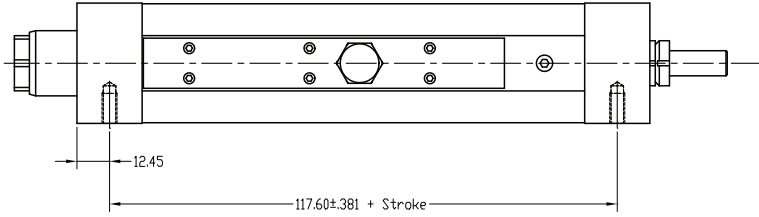
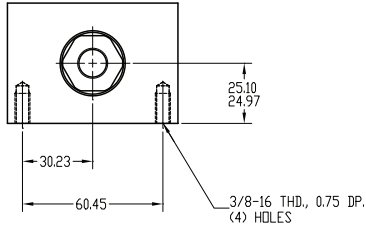

HD201 Front Flange Mount Dimensions

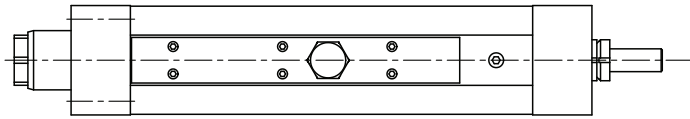
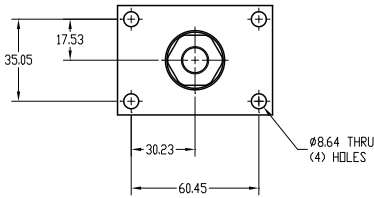

HD201 Foot Mount Dimensions

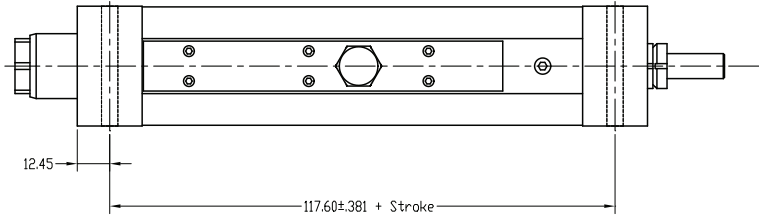
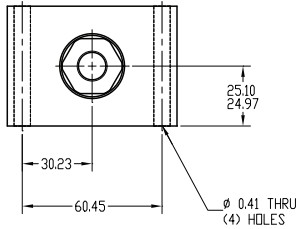

HD201 Trunnion Front Mount or Rear Mount Dimensions

