

Eliminator HD404 Actuator
With Switch Tracks for Mounting Limit Switches
English Dimensions

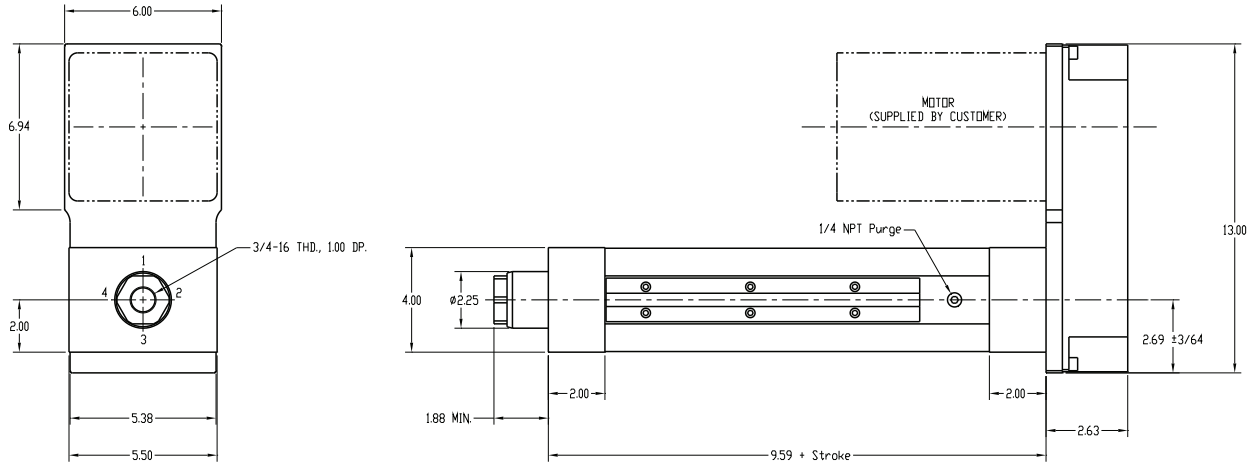

Motor Mount Configurations (*choose one*)

HD404 Parallel Offset Motor Configuration



HD404 Inline Motor Configuration

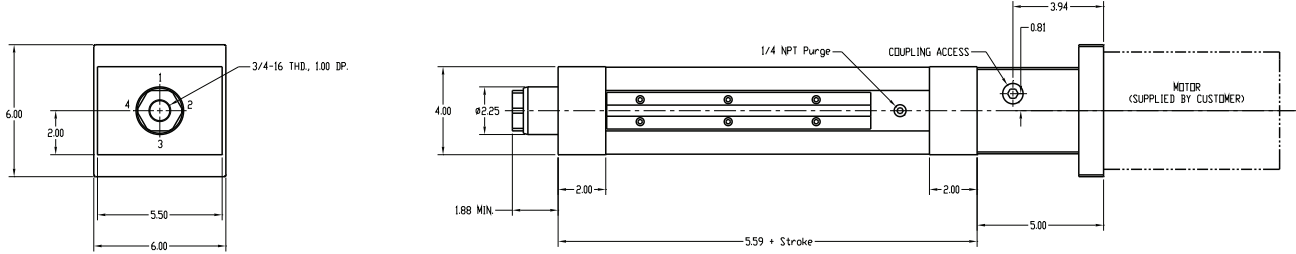

HD404 Rod End Conditions (*choose one*)

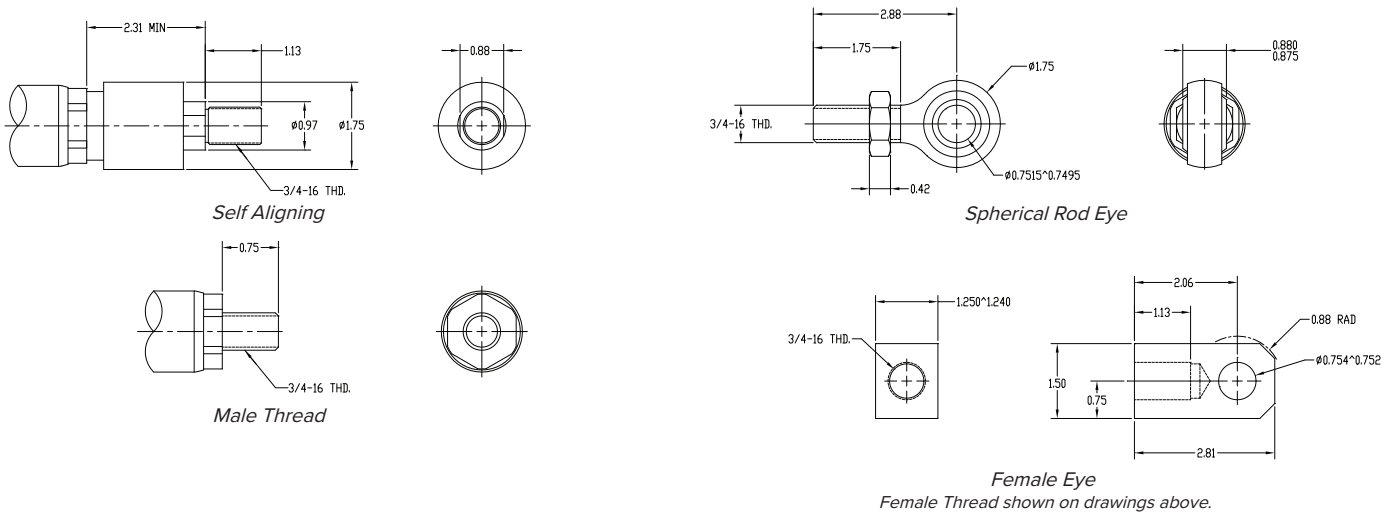

Eliminator HD404 Actuator
With Switch Tracks for Mounting Limit Switches
English Dimensions



HD404 Actuator Mount Configurations (*choose one*)

HD404 Bottom Mount Dimensions

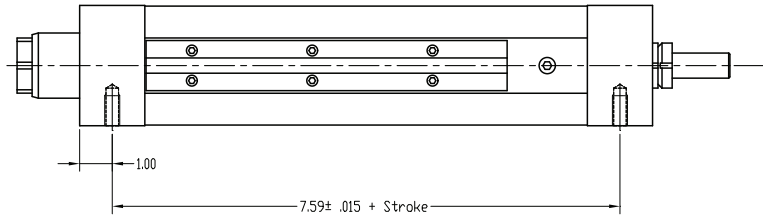
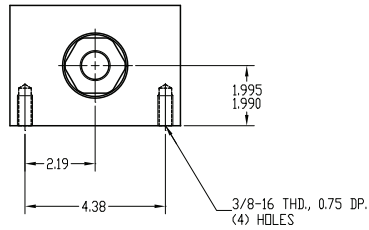

HD404 Front Flange Mount Dimensions

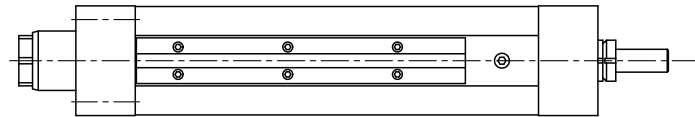
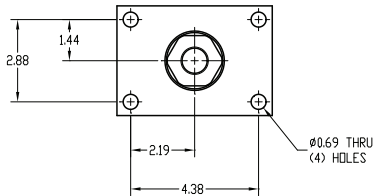

HD404 Foot Mount Dimensions

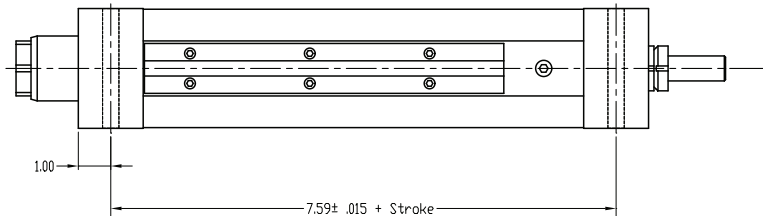
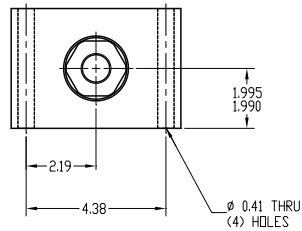

HD404 Trunnion Front Mount or Rear Mount Dimensions

