

**Eliminator HD508 Actuator**  
With Switch Tracks for Mounting Limit Switches  
Metric Dimensions

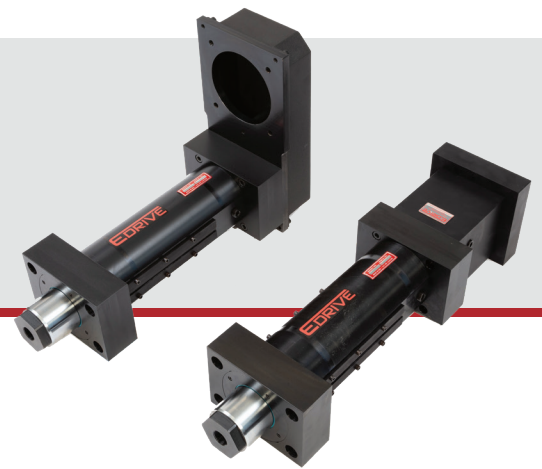

**Motor Mount Configurations (choose one)**

**HD508 Parallel Offset Motor Configuration**

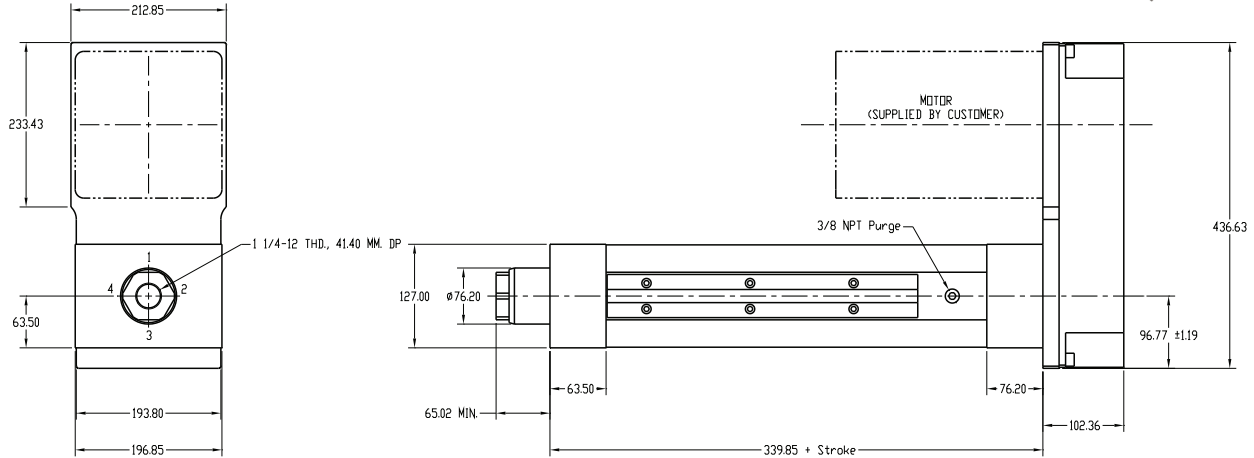

**HD508 Inline Motor Configuration**

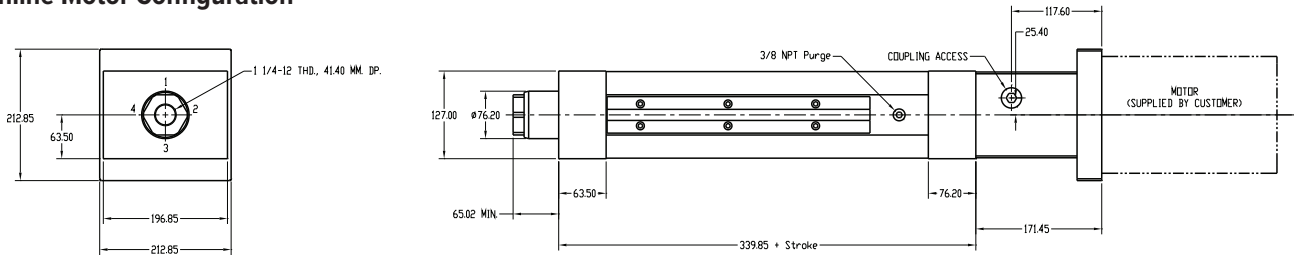

**HD508 Rod End Conditions (choose one)**

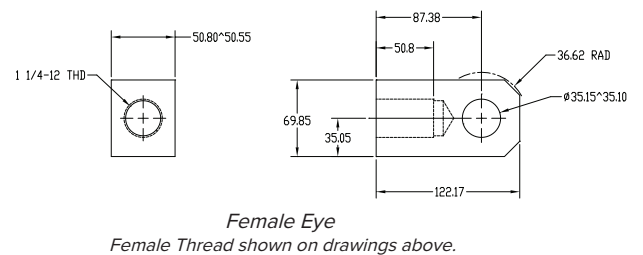
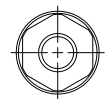
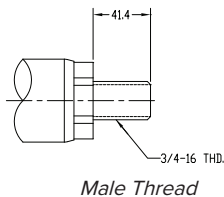
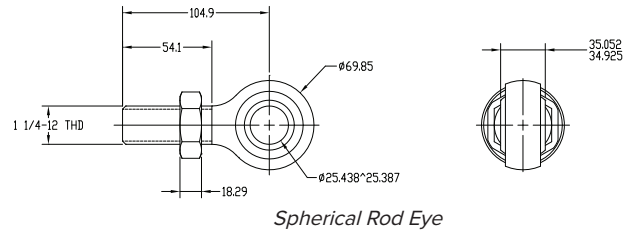
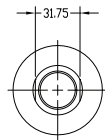
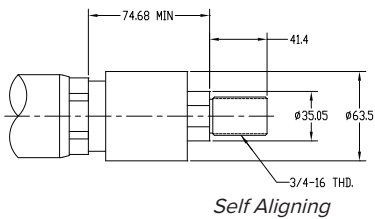

**Eliminator HD508 Actuator**  
With Switch Tracks for Mounting Limit Switches  
Metric Dimensions

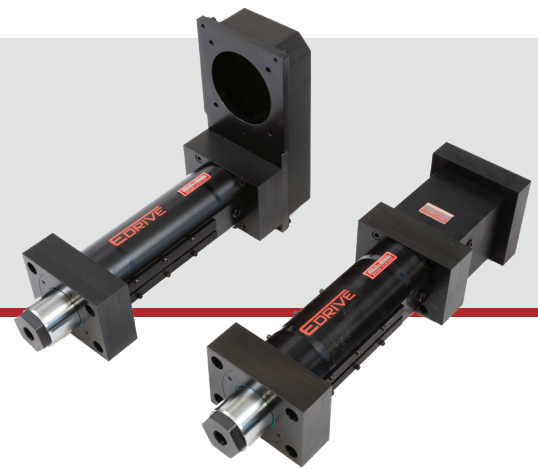

**HD508 Actuator Mount Configurations** (*choose one*)

**HD508 Bottom Mount Dimensions**

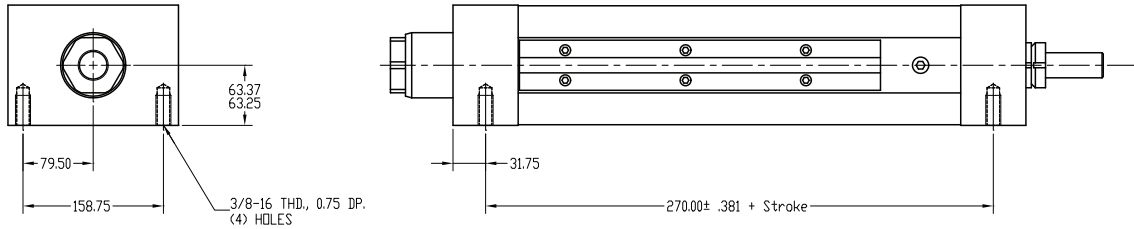

**HD508 Front Flange Mount Dimensions**

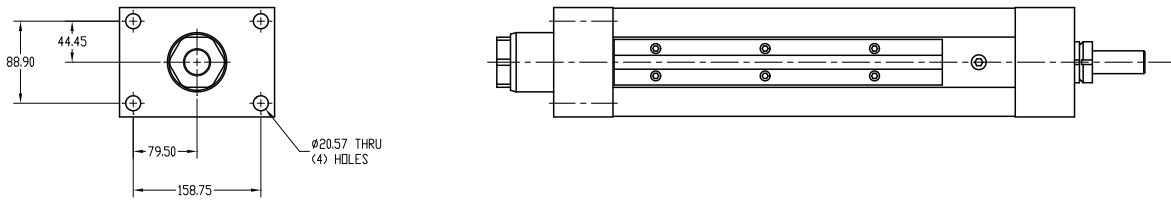

**HD508 Foot Mount Dimensions**

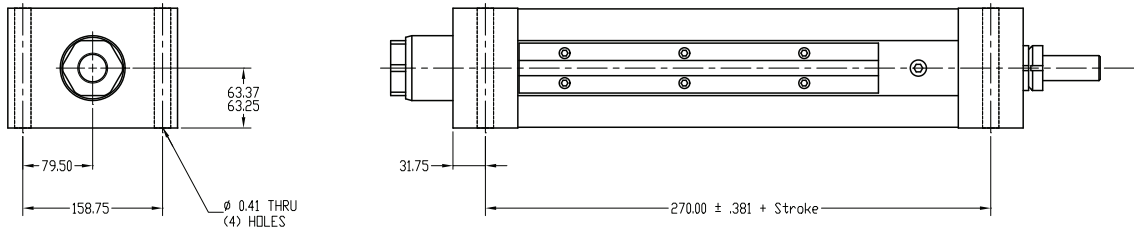

**HD508 Trunnion Front Mount or Rear Mount Dimensions**

