

Eliminator HD516 Actuator
Without Switch Tracks for Mounting Limit Switches
Metric Dimensions

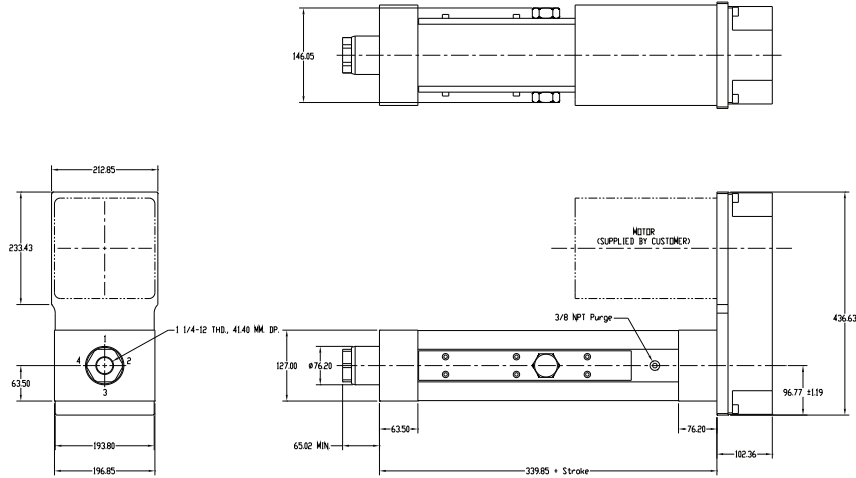

Motor Mount Configurations (choose one)

HD516 Parallel Offset Motor Configuration



HD516 Inline Motor Configuration

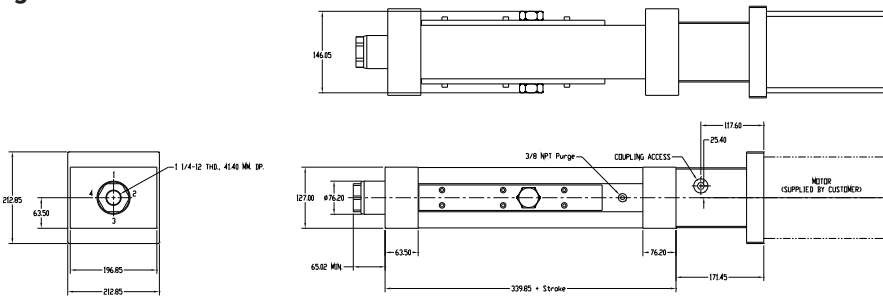

HD516 Rod End Conditions (choose one)

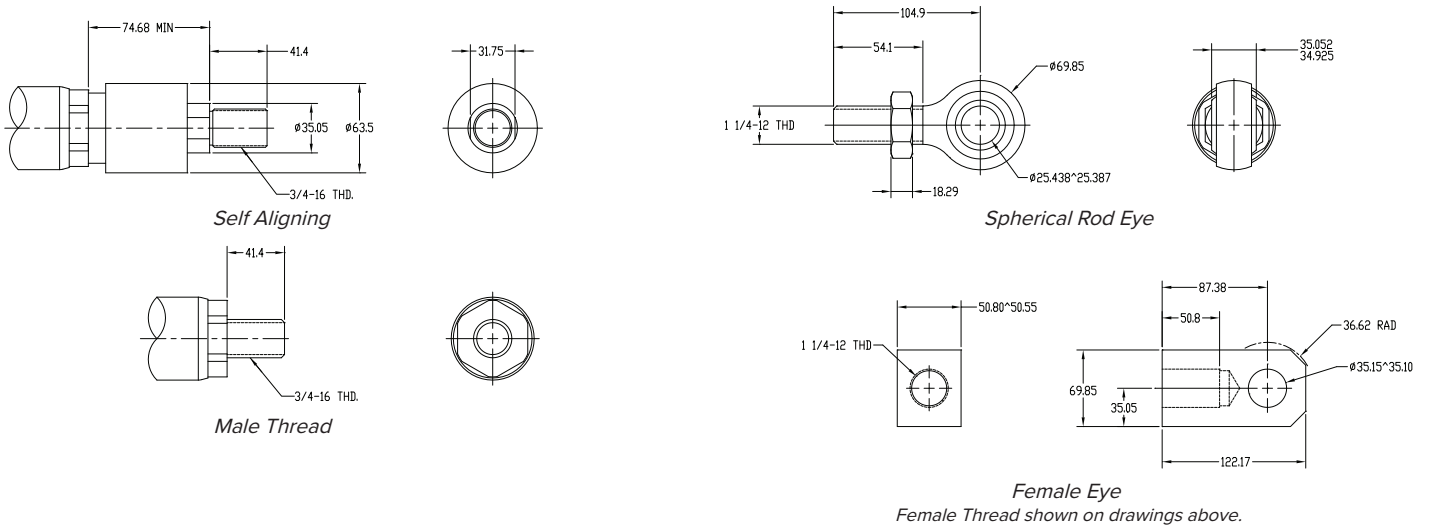

Eliminator HD516 Actuator
Without Switch Tracks for Mounting Limit Switches
Metric Dimensions

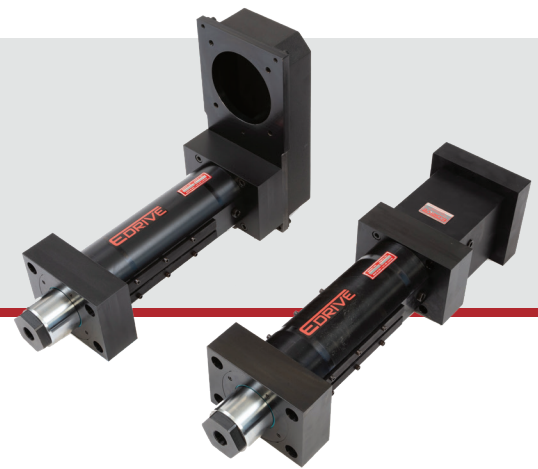

HD516 Actuator Mount Configurations (*choose one*)

HD516 Bottom Mount Dimensions

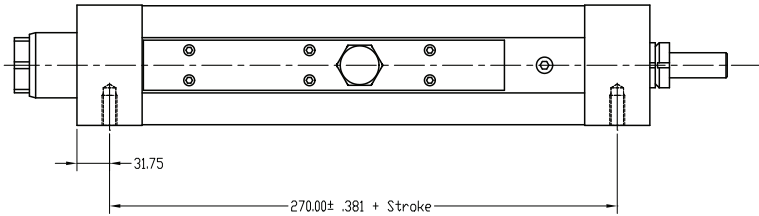
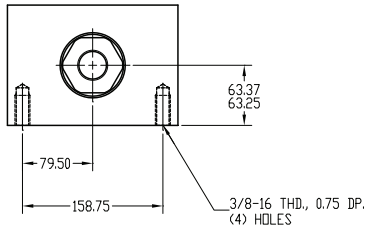

HD516 Front Flange Mount Dimensions

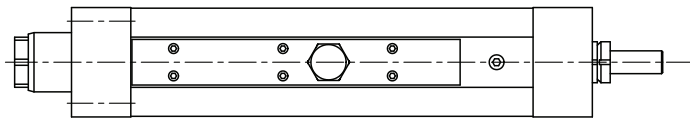
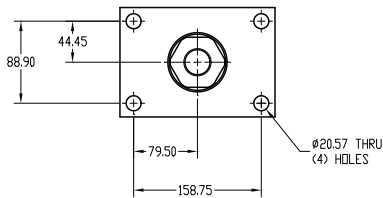

HD516 Foot Mount Dimensions

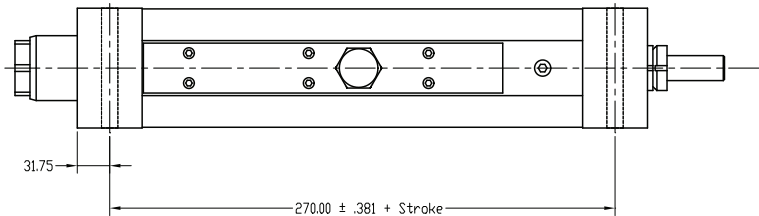
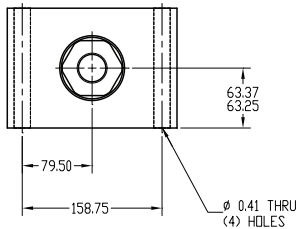

HD516 Trunnion Front Mount or Rear Mount Dimensions

