

Eliminator HD618 Actuator
Without Switch Tracks for Mounting Limit Switches
Metric Dimensions

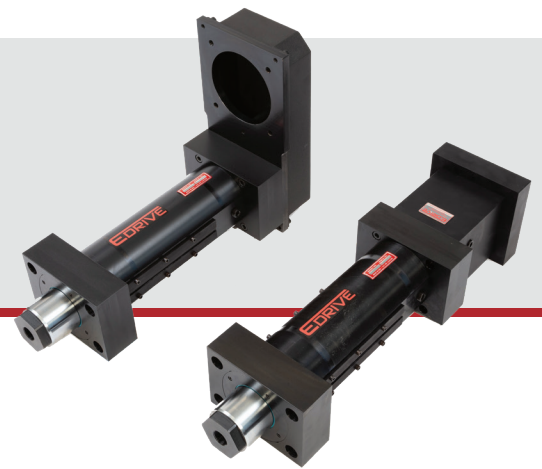

Motor Mount Configurations (choose one)

HD618 Parallel Offset Motor Configuration

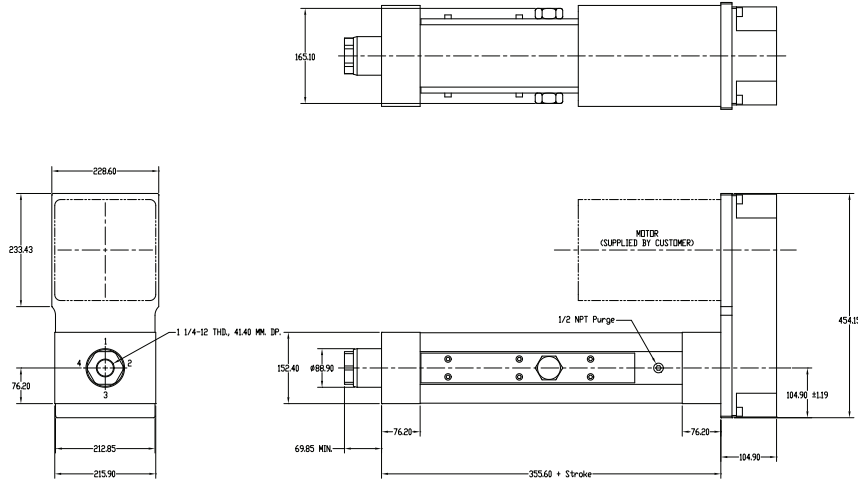

HD618 Inline Motor Configuration

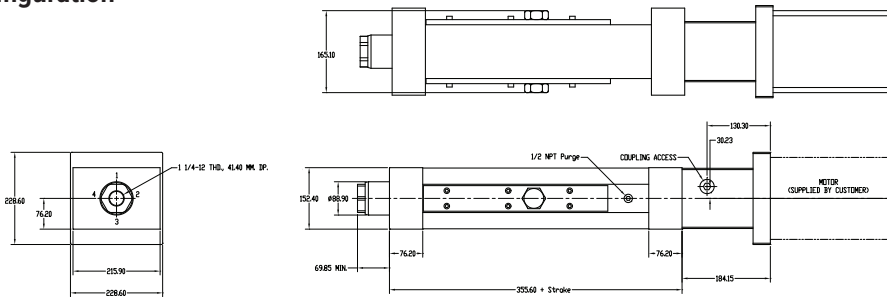

HD618 Rod End Conditions (choose one)

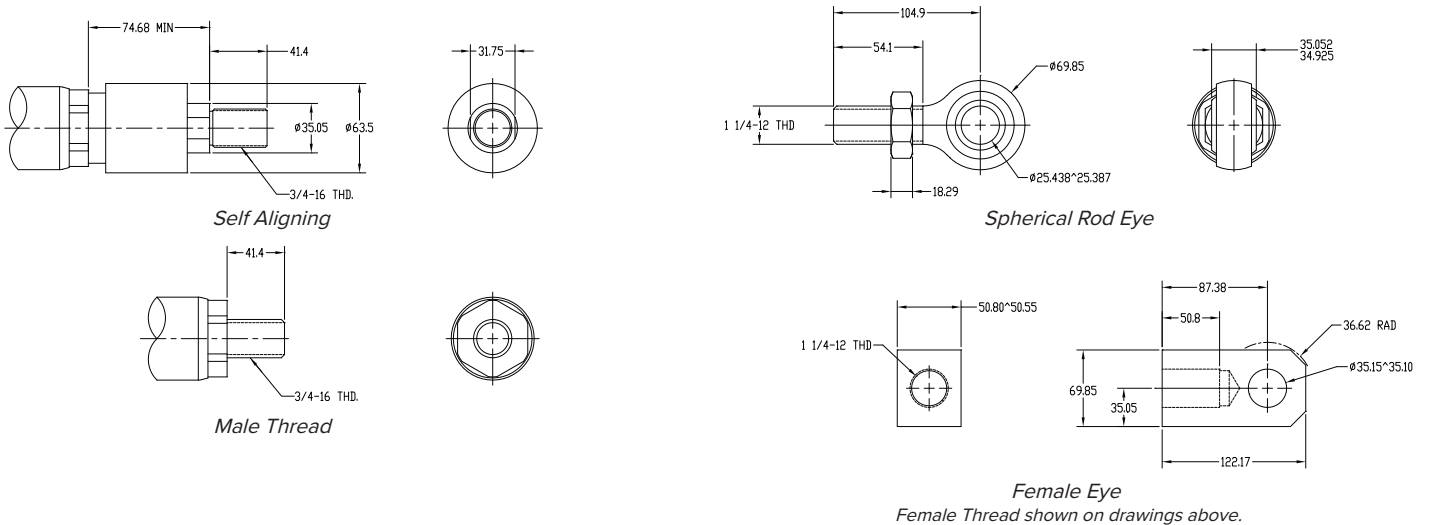

Eliminator HD618 Actuator
Without Switch Tracks for Mounting Limit Switches
Metric Dimensions

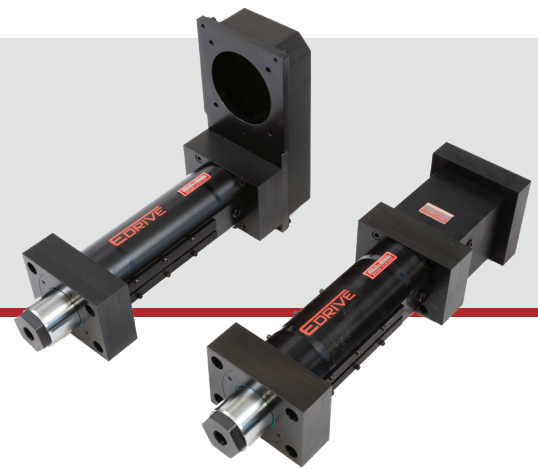

HD618 Actuator Mount Configurations (*choose one*)

HD618 Bottom Mount Dimensions

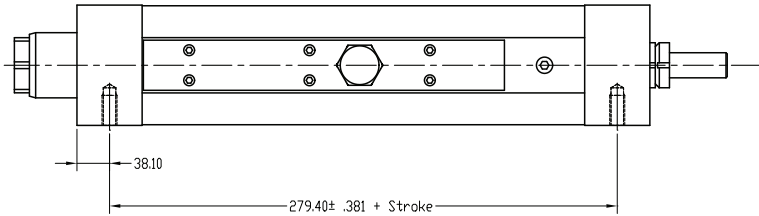
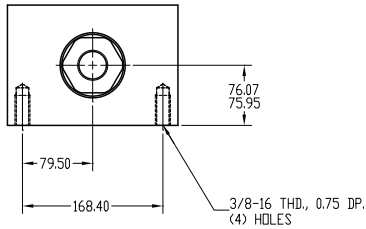

HD618 Front Flange Mount Dimensions

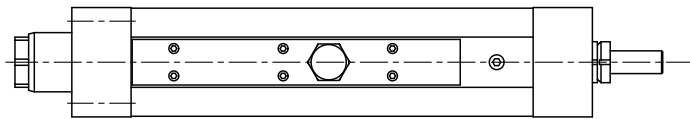
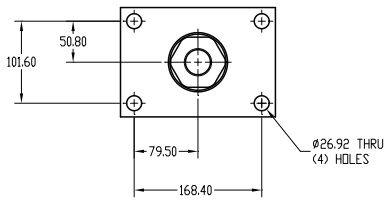

HD618 Foot Mount Dimensions

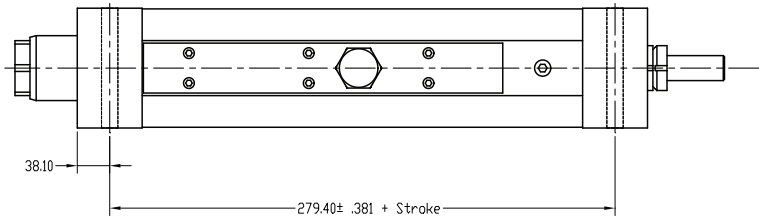
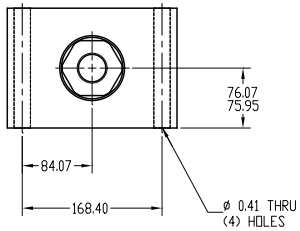

HD618 Trunnion Front Mount or Rear Mount Dimensions

