

Eliminator HD625 Actuator
With Switch Tracks for Mounting Limit Switches
Metric Dimensions

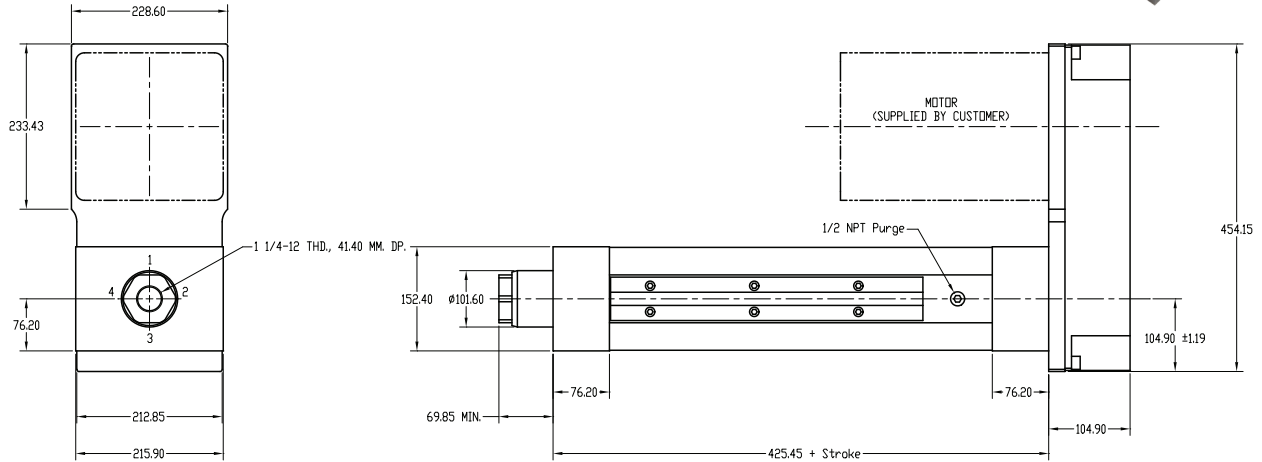

Motor Mount Configurations (choose one)

HD625 Parallel Offset Motor Configuration



HD625 Inline Motor Configuration

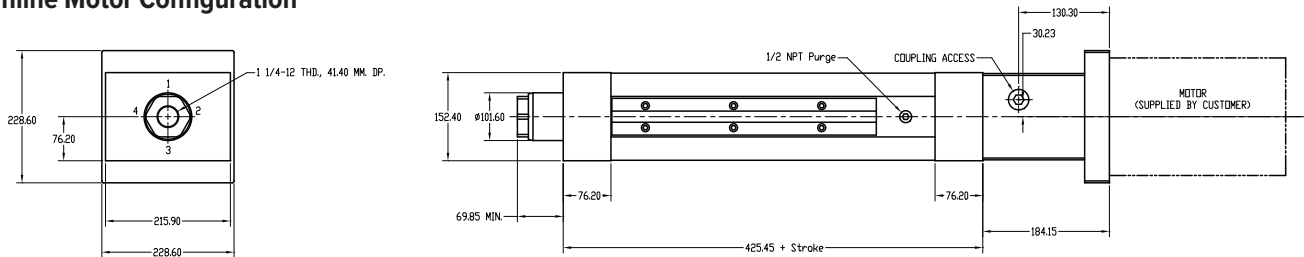

HD625 Rod End Conditions (choose one)

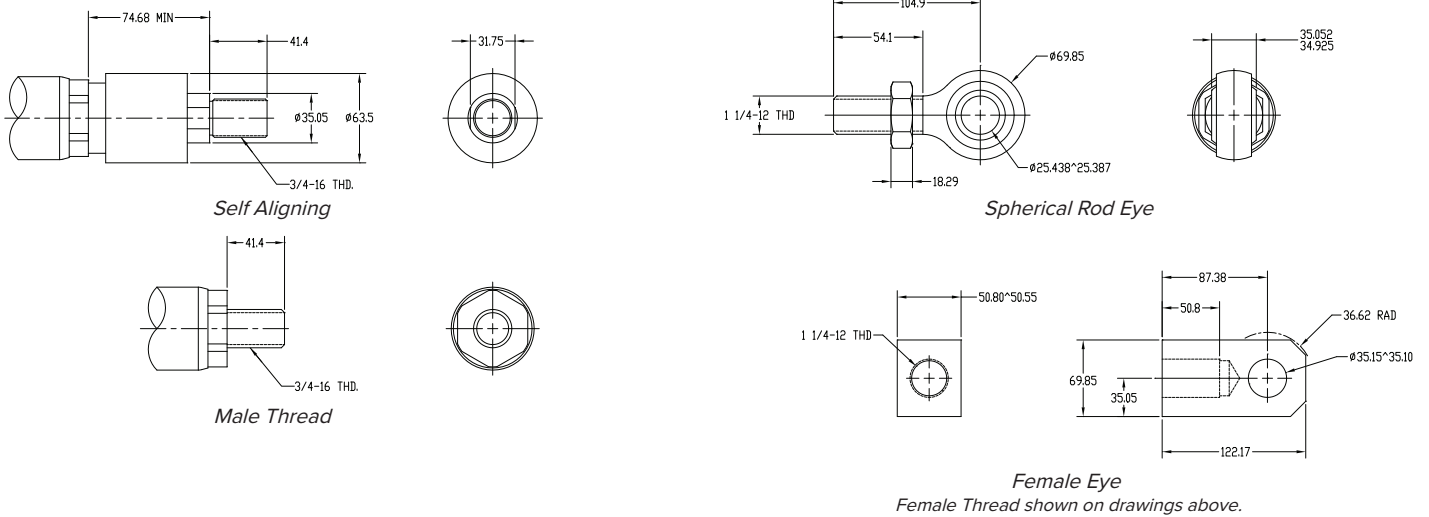

Eliminator HD625 Actuator
With Switch Tracks for Mounting Limit Switches
Metric Dimensions

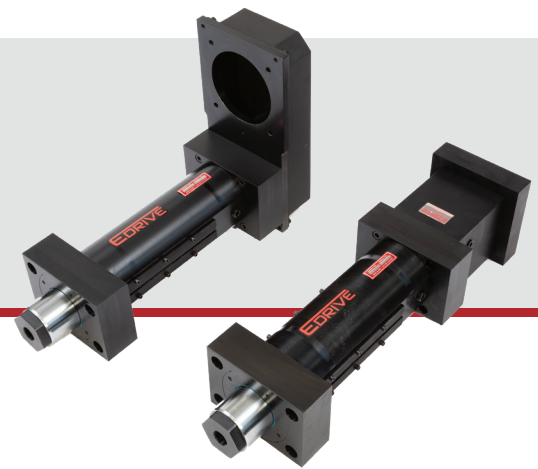

HD625 Actuator Mount Configurations (*choose one*)

HD625 Bottom Mount Dimensions

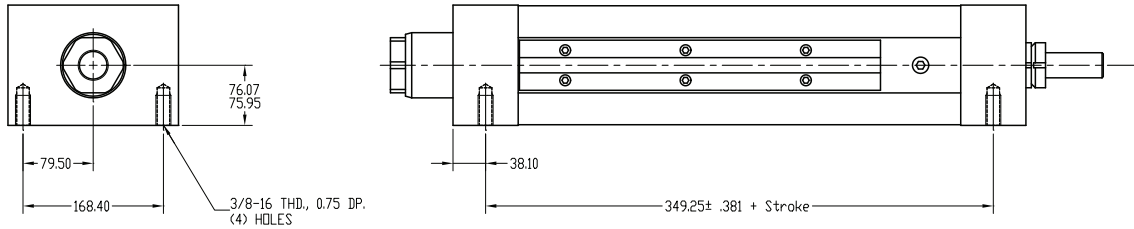

HD625 Front Flange Mount Dimensions

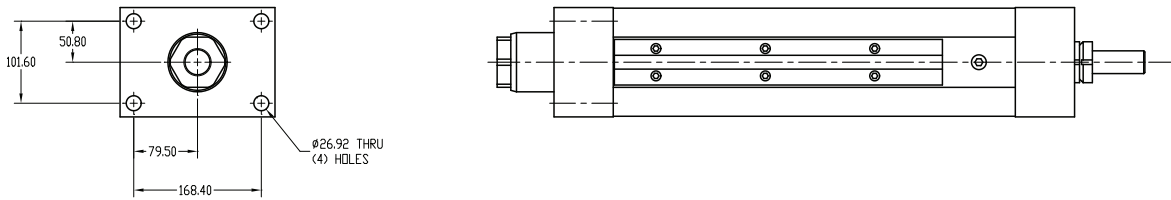

HD625 Foot Mount Dimensions

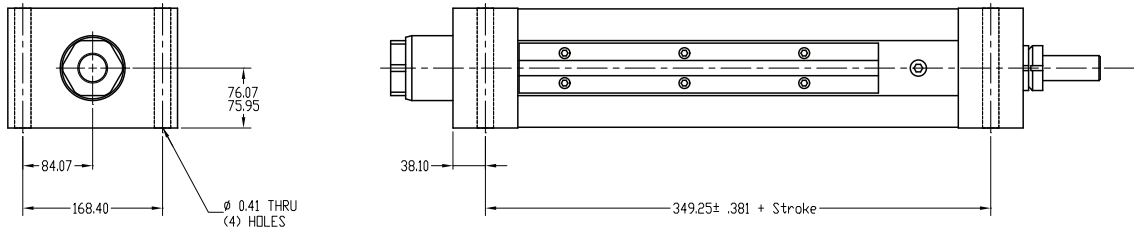

HD625 Trunnion Front Mount or Rear Mount Dimensions

